

viewmaster^x

Warranty

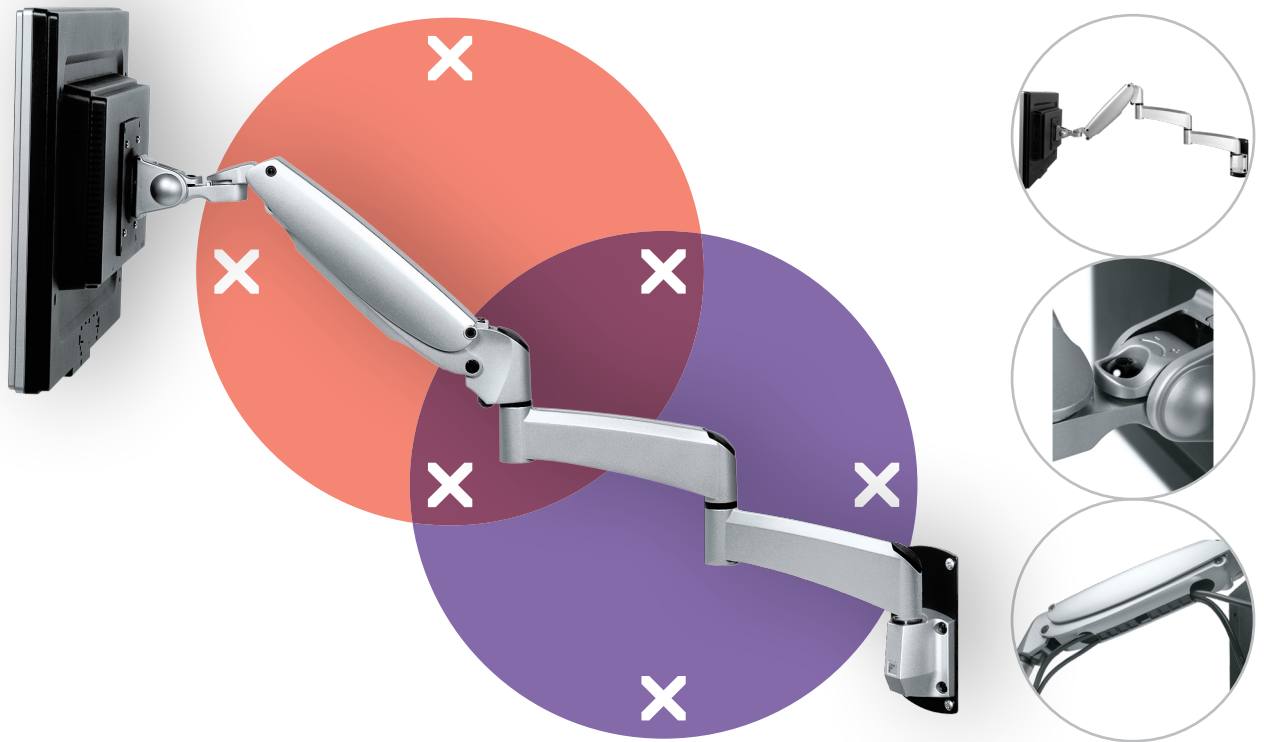

57.282

Viewmaster monitor arm - wall 282

Remarkably long reach and dynamic height adjustability with fingertip sensitive balance make it easy to find the optimal ergonomic position across even a large area. The folding extensions keep things compact when needed and cables are easily guided along the arm's extensions to create a tidy, professional impression.

- Dynamic height adjustment range of 305 mm (12,0")
- Increased independent depth adjustment
- Partly integrated or concealed cable management
- Main components made of aluminium
- VESA MIS-D 75 x 75/100 x 100 mm compatible
- Monitor: tilt +90°/-90°, swivel +90°/-90°, rotate +90°/-90°
- Arm: swivel +90°/-90°
- Weight capacity min. 4,5 - max. 10 kg (9,9 - 22 lb) per monitor
- Comes with a wall mount
- Built-in SUSPA® gas spring
- Listed weight capacity will vary when mounting monitors that are deeper than 25 mm (1,0") or have an off-centre VESA mount position

dataflex

feeling at work

viewmaster x

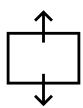
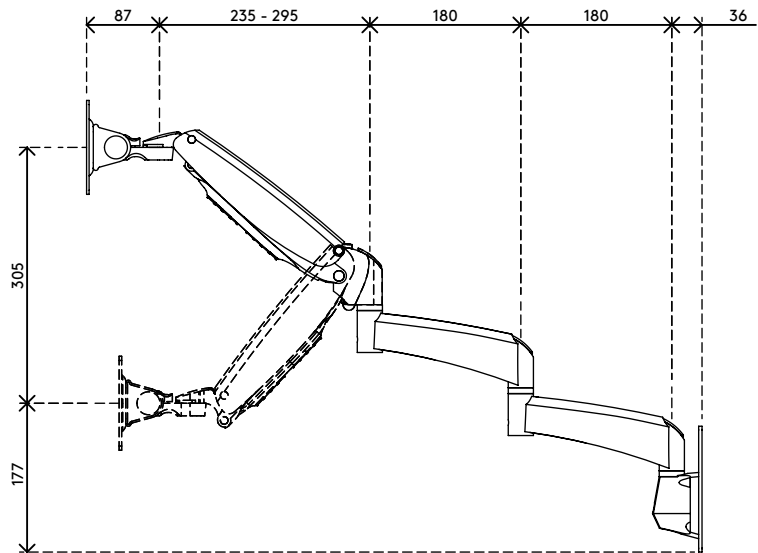
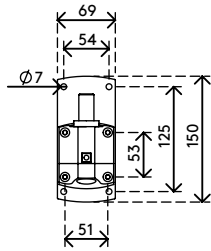
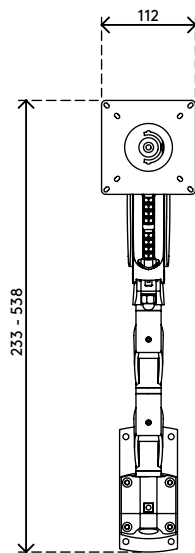
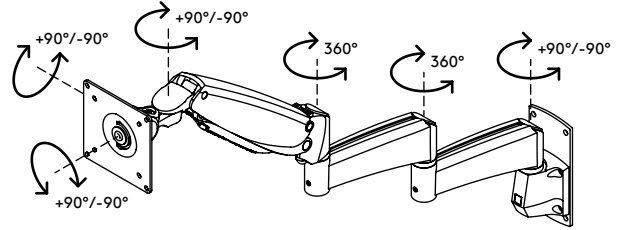
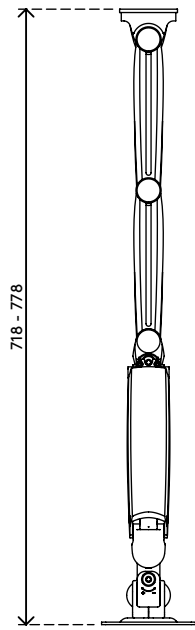

305 mm (12,0")



+90°/-90°



+90°/-90°



+90°/-90°



75 x 75/100 x 100



4,5 - 10 kg (9,9 - 22 lb)

Viewmaster monitor arm - wall 282

2020/10/06

57.282

 490 x 285 x 140 mm

 1 pcs

 silver

 4,305 kg

 805410572822